

FRONT

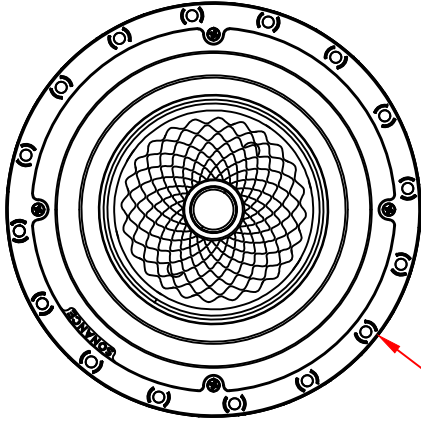

$\phi 281.1$ [$\phi 11.07$]

BACK / MINIMUM CUTOUT

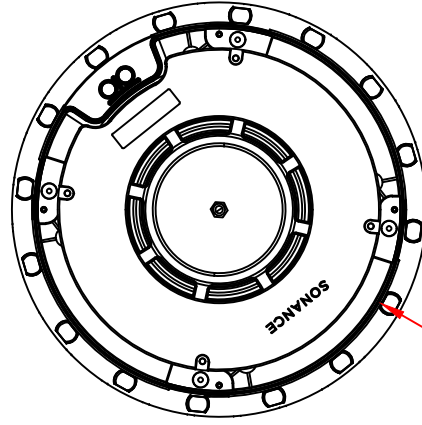

$\phi 253.9$ [$\phi 10.00$]

MOUNTING DEPTH

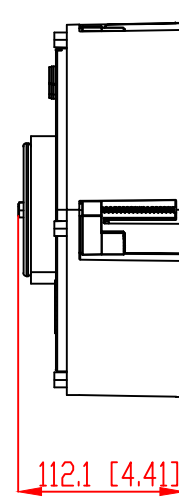

112.1 [4.41]

MICRO TRIM GRILLE

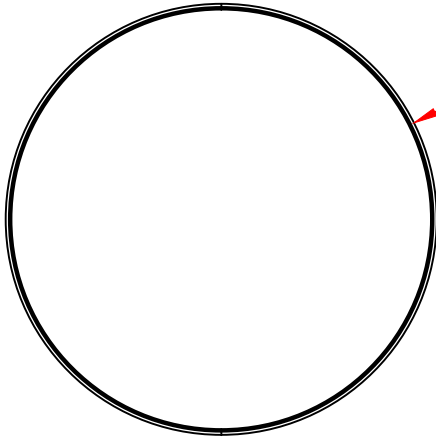

$\phi 292.6$ [$\phi 11.52$]

4 [0.16]

TRIMLESS GRILLE

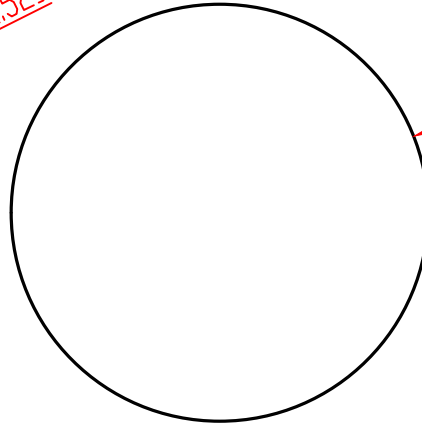

$\phi 283.8$ [$\phi 11.17$]

3.6 [0.14]

ISOMETRIC

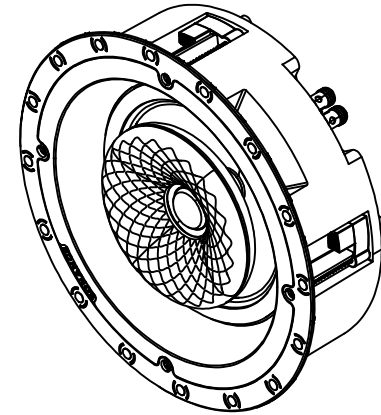

991 Calle Amanecer
San Clemente, California 92673 USA
949-492-7777
www.sonance.com

VX80R SPEAKER

SCALE: 4:5
SHEET: 0F

DRAWN - PART NUMBER

REV.

SONANCE